

1

Unilift KP 250 AV 1



: 012H1400

1-

F,

,5

10

: 0 .. 50 °C
998.2 / 3

: 10

DIN W.-Nr. 1.4301
AISI 304

DIN W.-Nr. 1.4031
AISI 304



012H1400 Unilift KP 250 AV 1 50

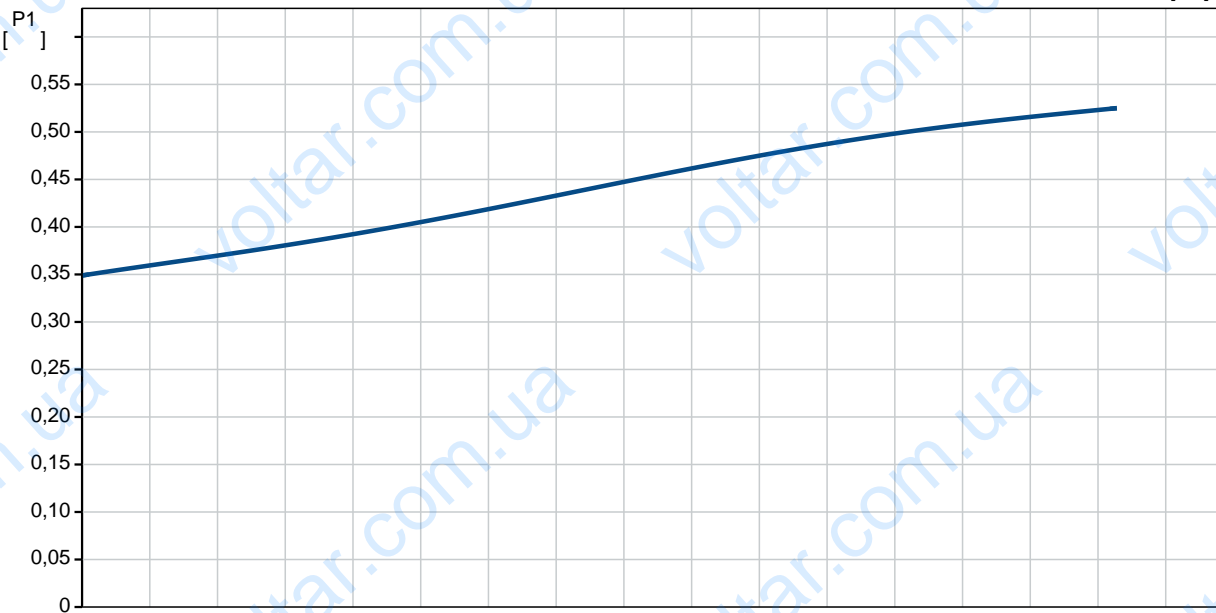
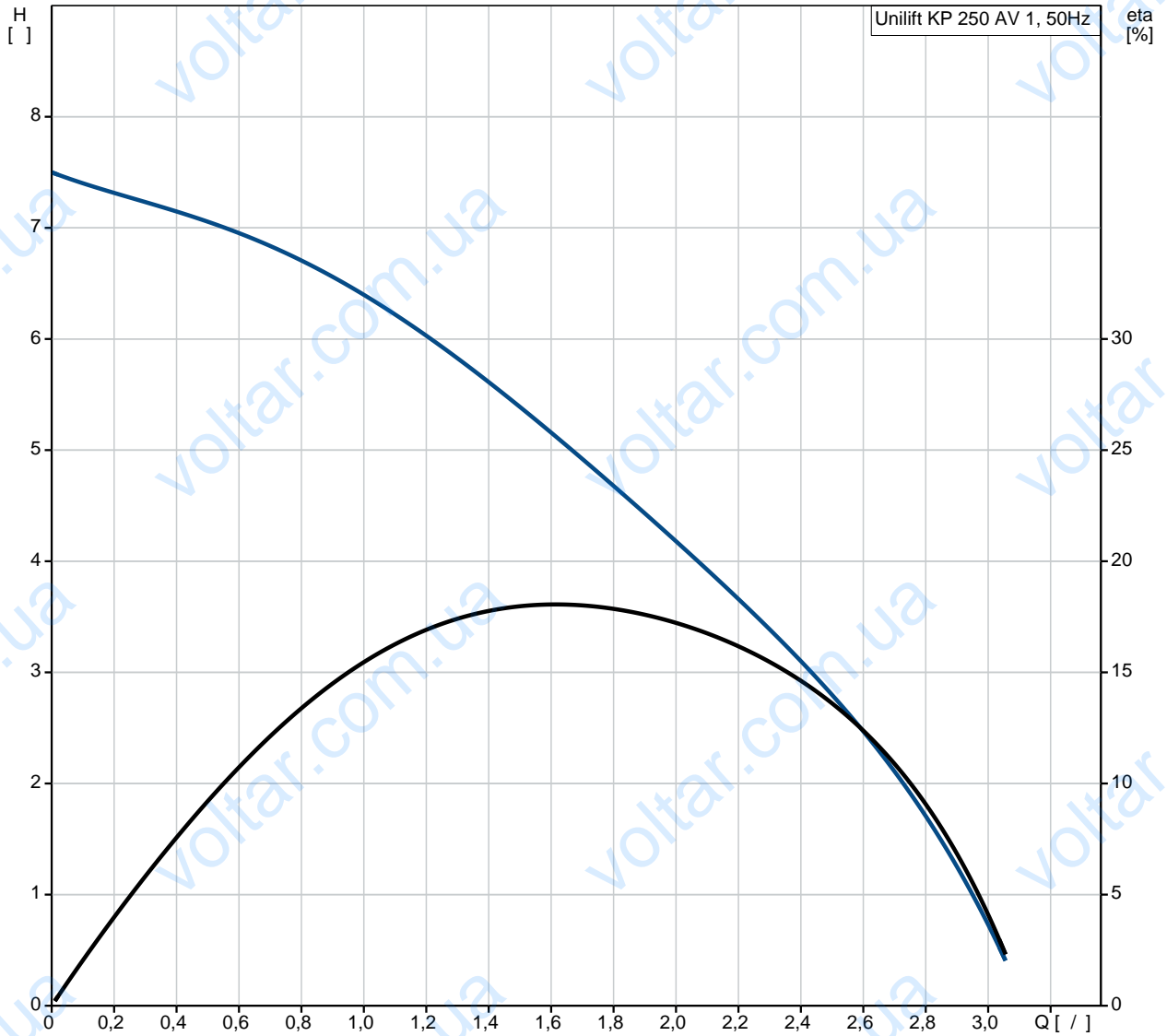

		Unilift KP 250 AV 1
		012H1400
EAN	:	5700391116544
Ma	:	3.11 /
	:	7.5
	:	10
	:	A
		DIN W.-Nr. 1.4301
		AISI 304
		DIN W.-Nr. 1.4031
		AISI 304
	:	Rp 1 1/4
	:	2
	:	0 .. 50 °C
	:	998.2 / ³
	- P1:	480
	:	50 Hz
	:	1 x 220-230
	:	2.3 A
	:	8 /400
(IEC 34-5):	:	IP68
(IEC 85):	:	F
	:	CONTACT
	:	5
	:	SCHUKO
	:	6.5
	:	7
	:	0.013 ³

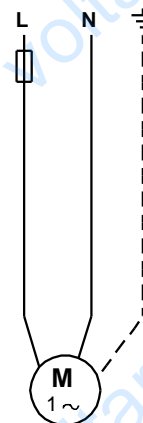
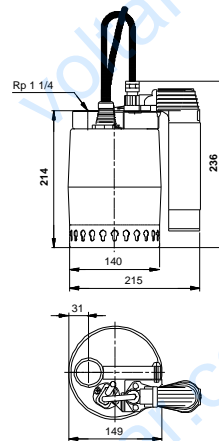
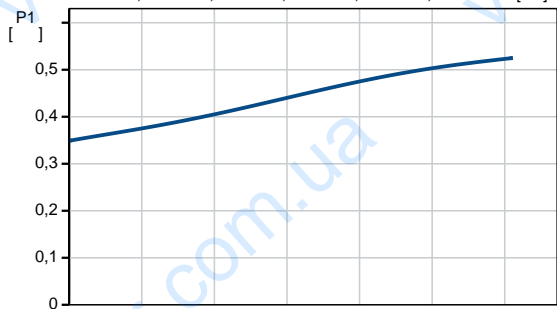
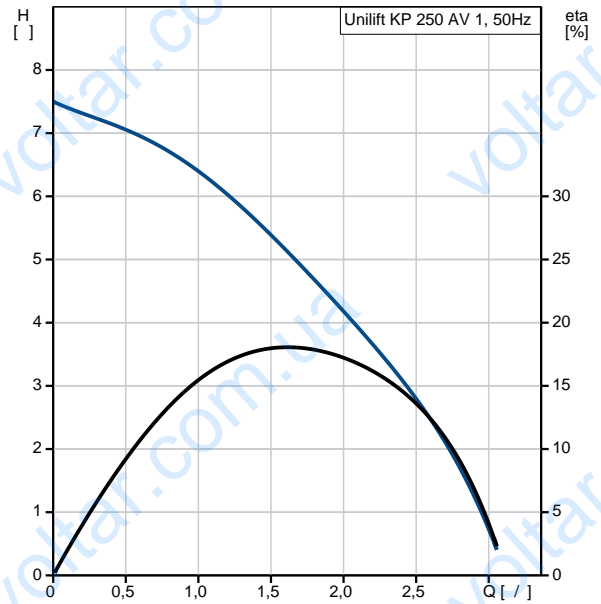

012H1400 Unilift KP 250 AV 1 50

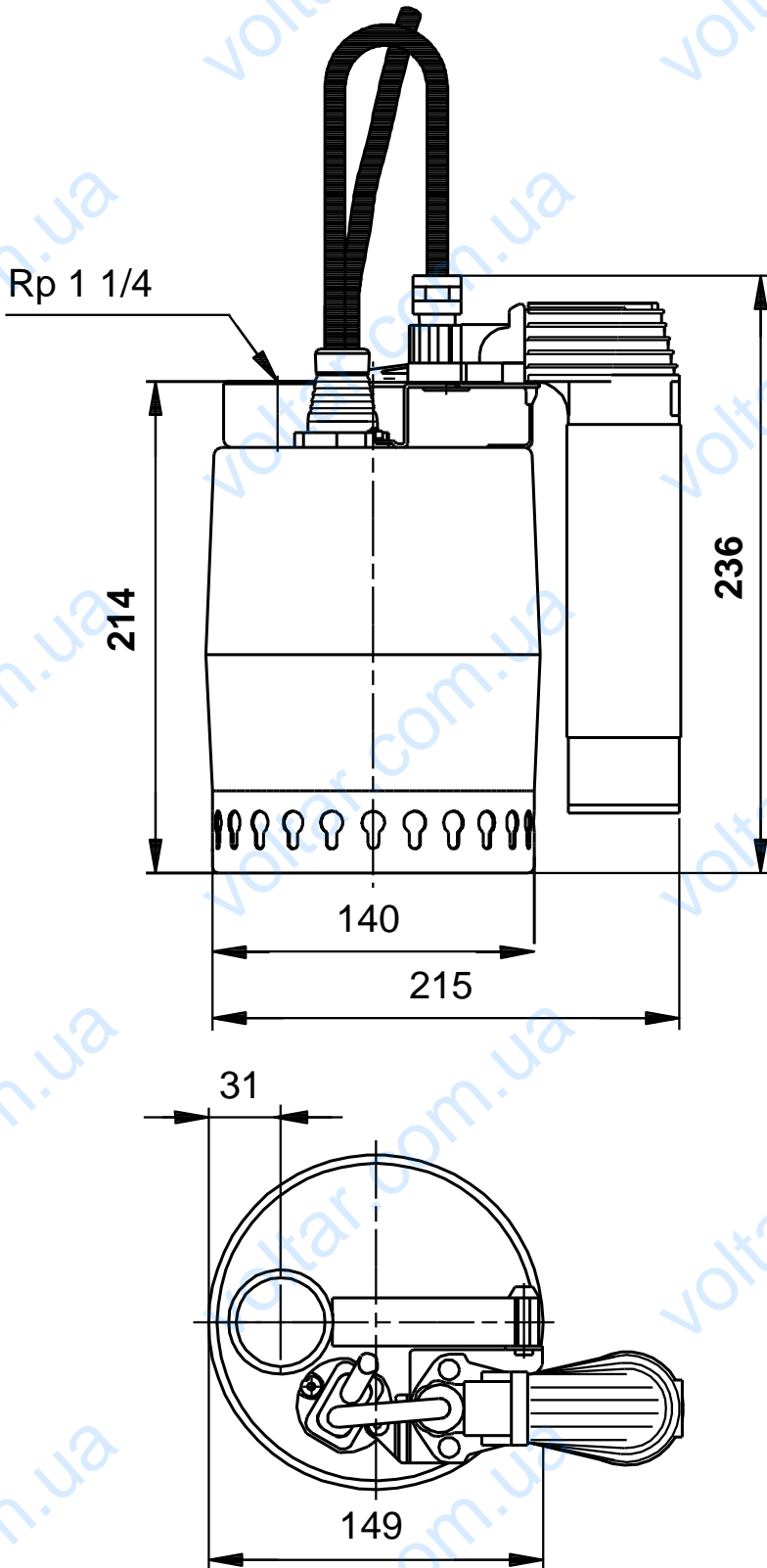

012H1400 Unilift KP 250 AV 1 50

