



www.esbe.se



**SERIES CRA120**



**NO.1 IN HYDRONIC SYSTEM CONTROL**

Mtrl.nr. 9814 03 92 • Ritn.nr. 9212 utg. B • Rev. 1012



Series CRA120

CE  
LVD 2006/95/EC  
EMC 2004/108/EC  
RoHS 2002/95/EEC

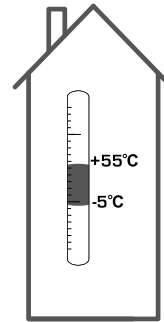

**1**

**2**

**3**

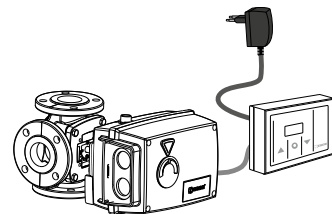
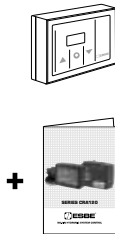
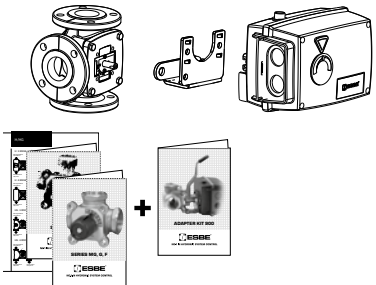

**1**

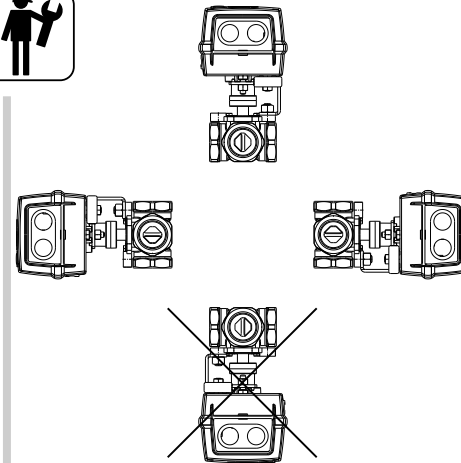

**2**

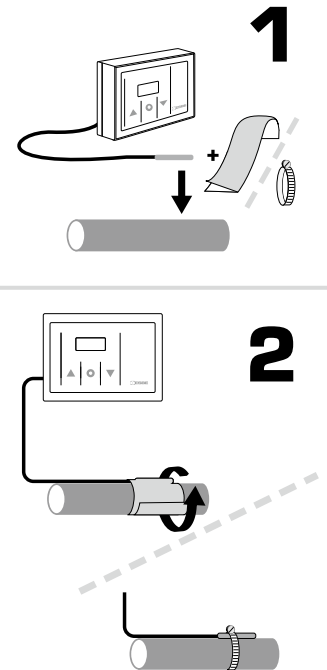

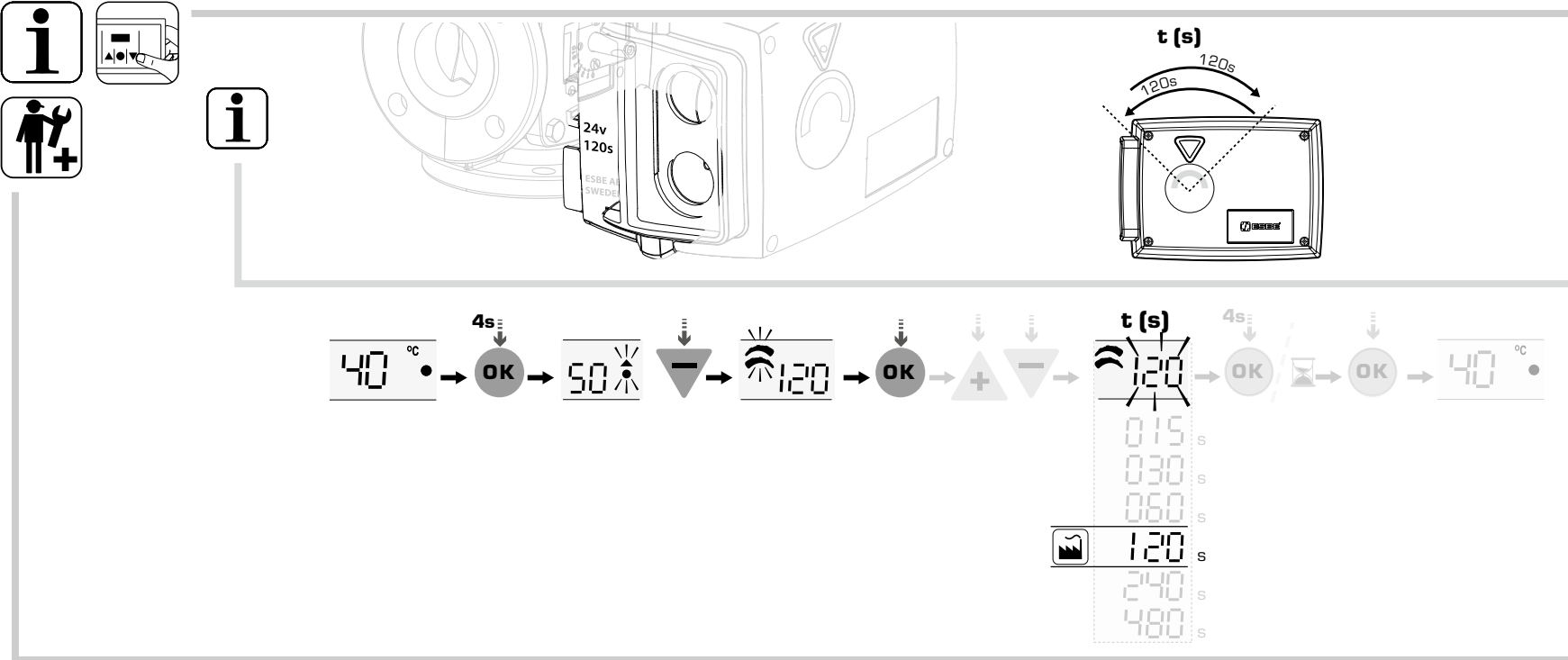
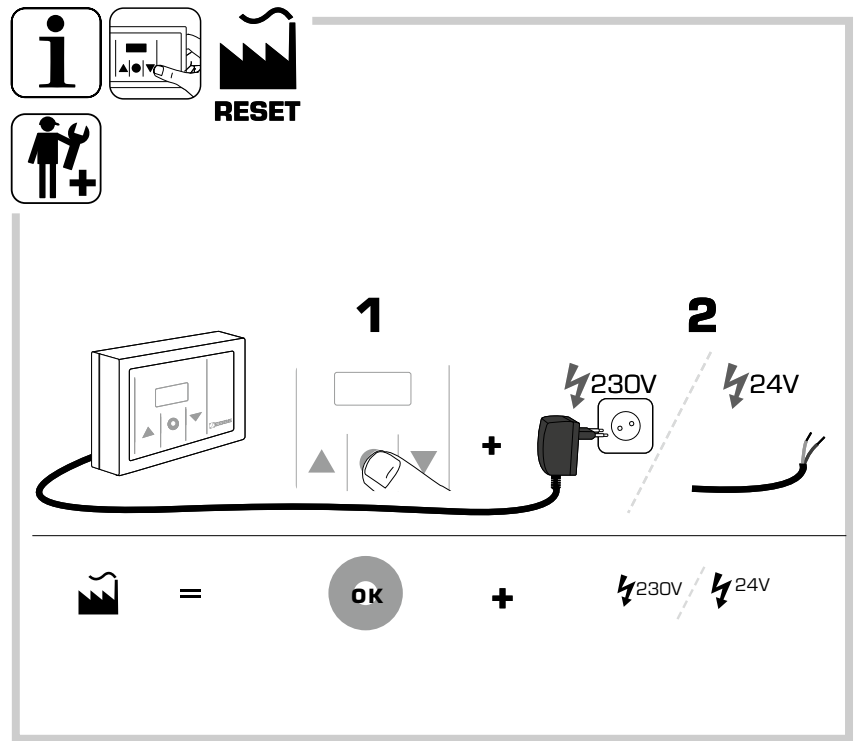
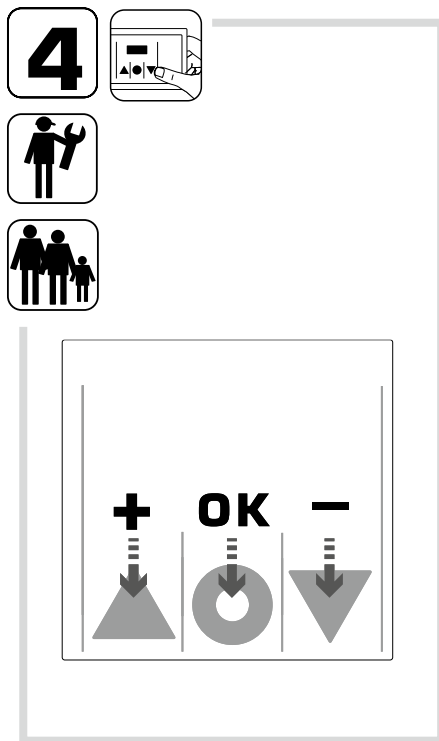
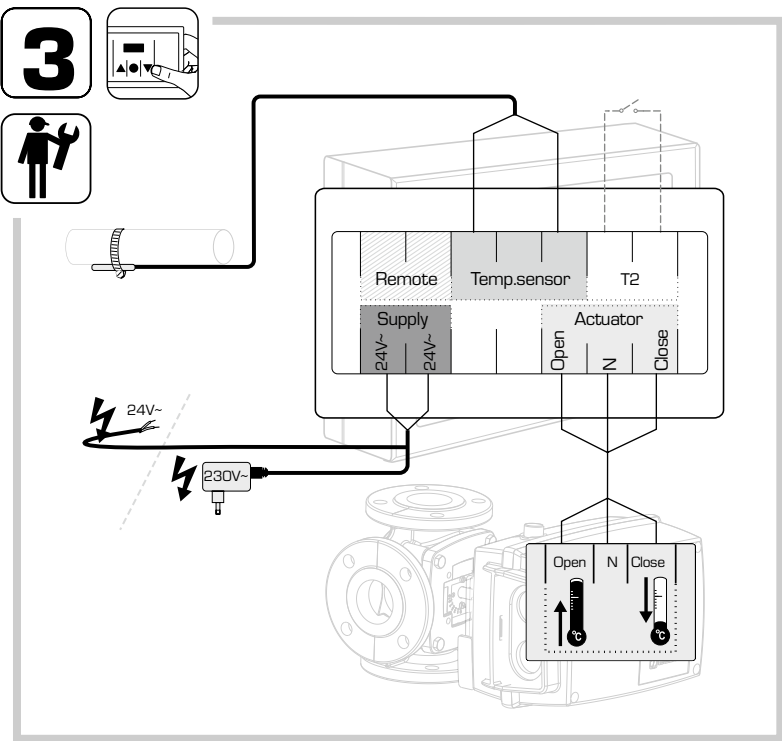

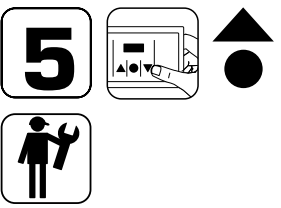

**i**

▲ = MAX °C

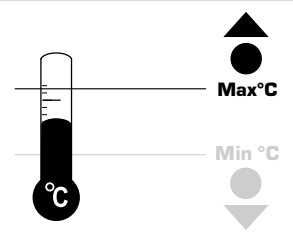
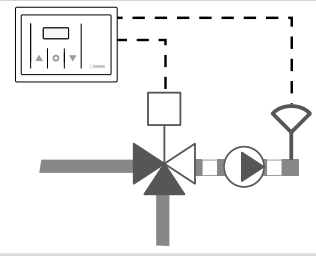

	50 °C
	~40 - 50 °C
	~60 - 80 °C
	60 °C

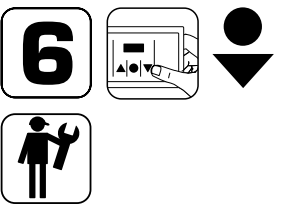
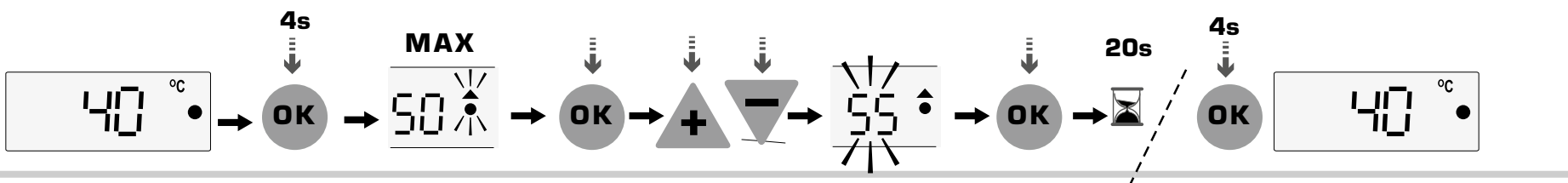

**i**

▼ = MIN °C

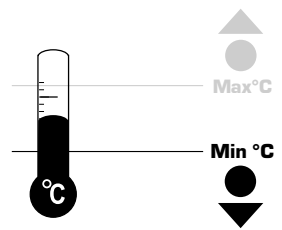
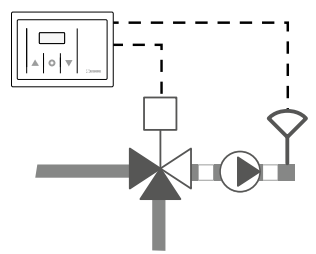

	5 °C
	~5 - 25 °C
	~5 - 25 °C
	~5 - 25 °C

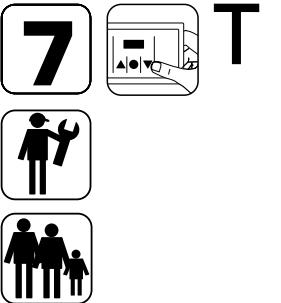
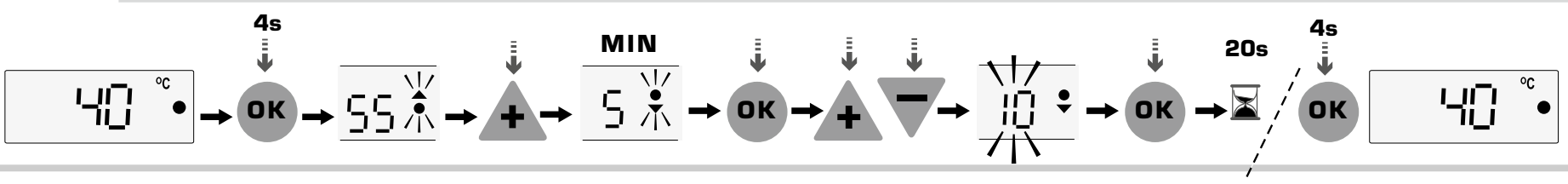

**i**

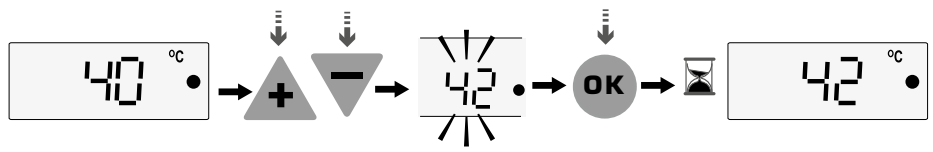
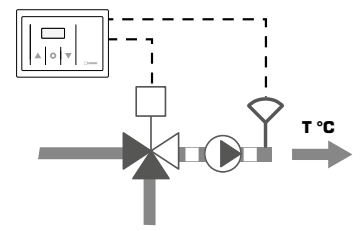
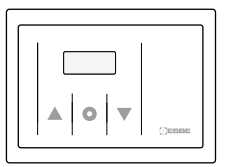

**i** **T2**

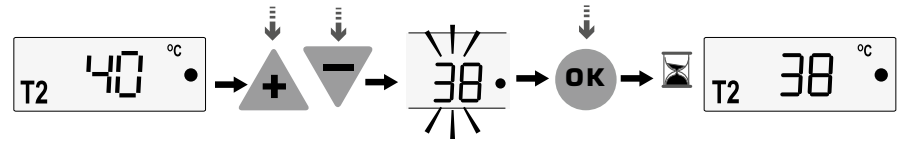
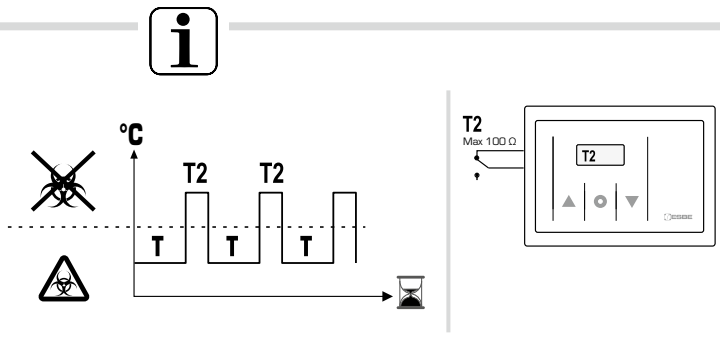
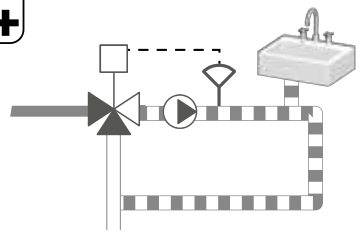

**T**

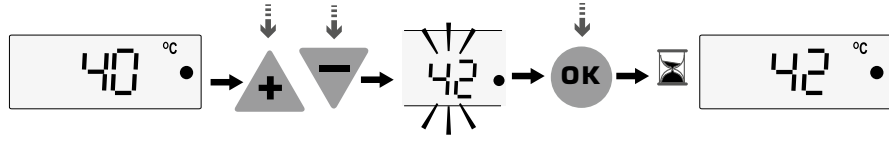
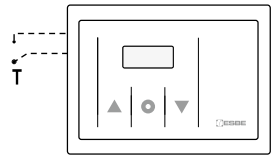

**i**



**1**



**2**

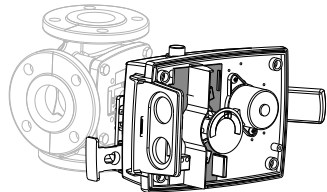
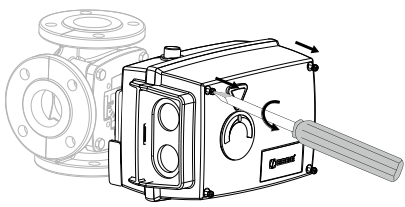

**3**

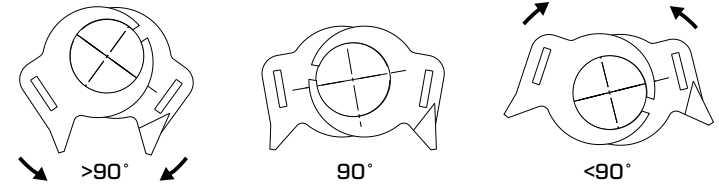
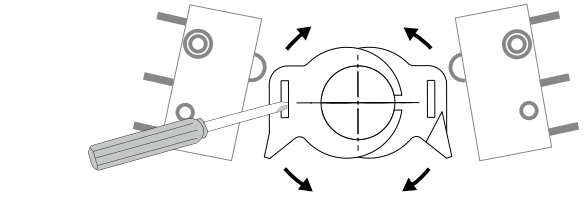
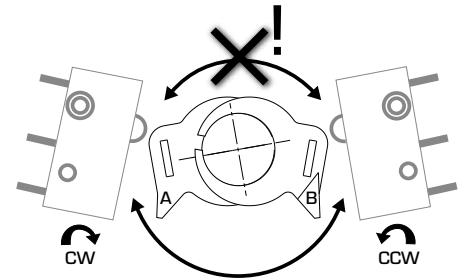

**4**

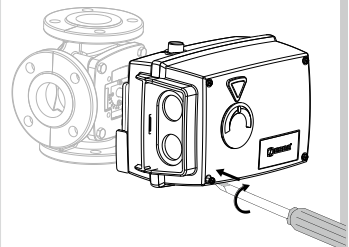

**5**

