

Side view

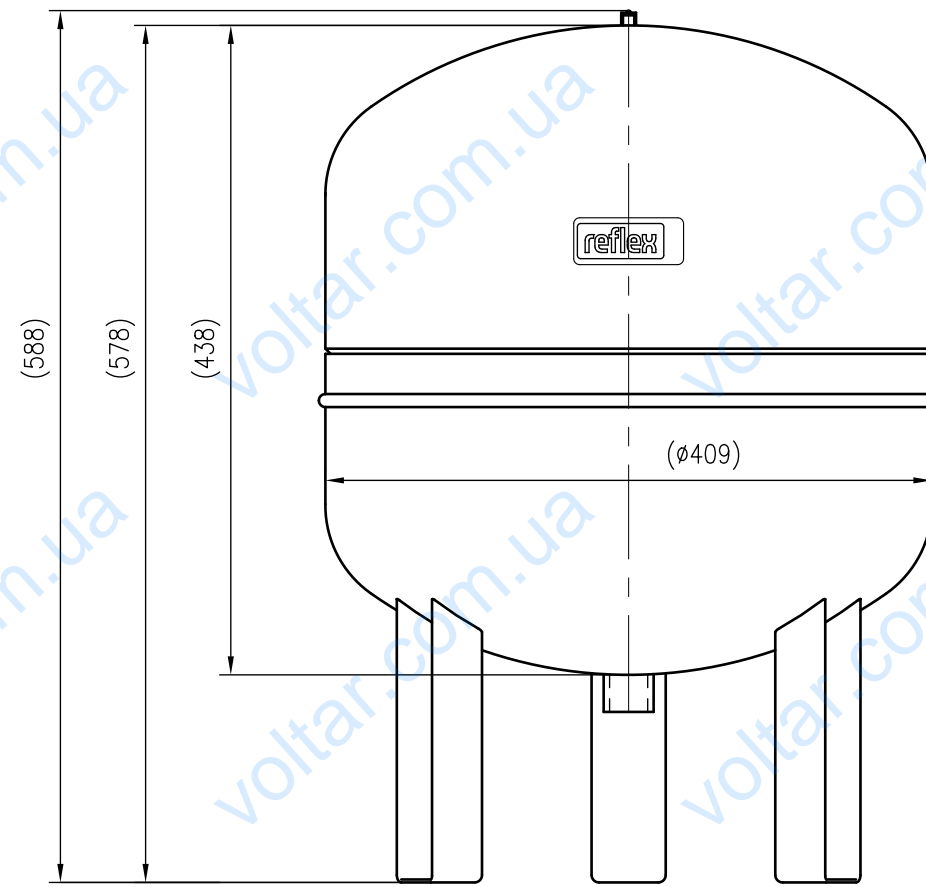

Front view

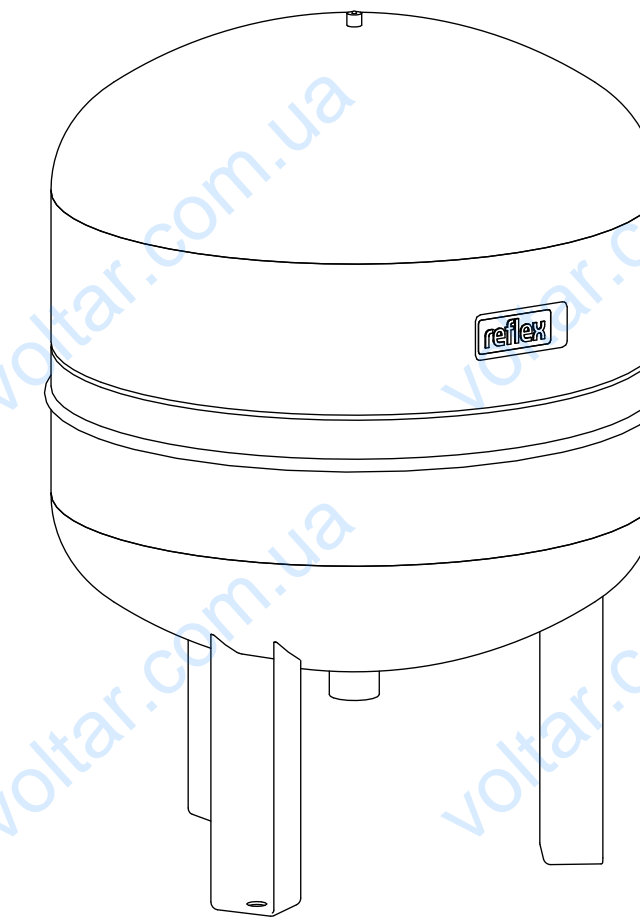

Isometric view

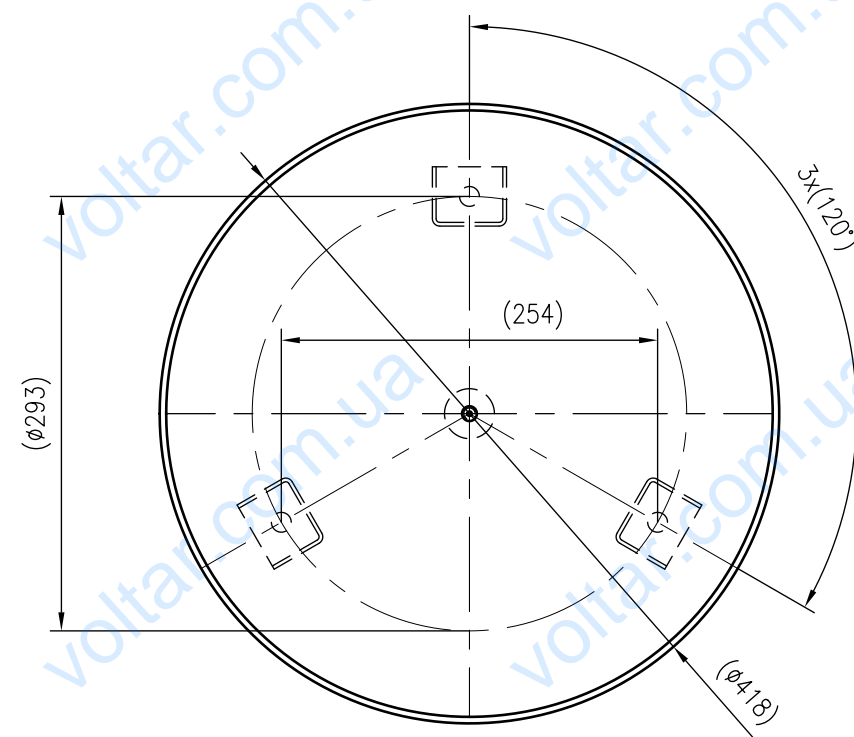

Top view



Unterliegt nicht dem Änderungsdienst/ Not subject to change management		Maßstab/ Scale: 1:5	Format/ Size: A2
Revision 29.04.2016	Refix DC 50 10bar – 7309600		