



SERIES VRG130



NO.1 IN HYDRONIC SYSTEM CONTROL



1

Series VRG131
Series VRG132
Series VRG133
Series VRG138
Series VRG139

PED 2014/68/EU, article 4.3

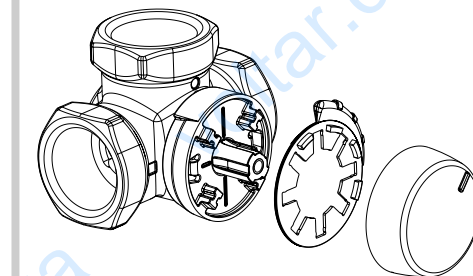
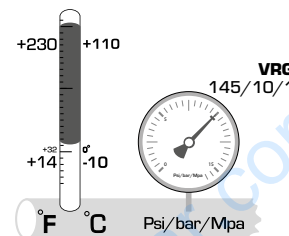
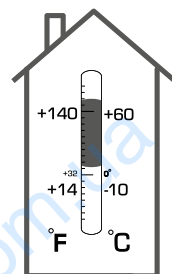

i

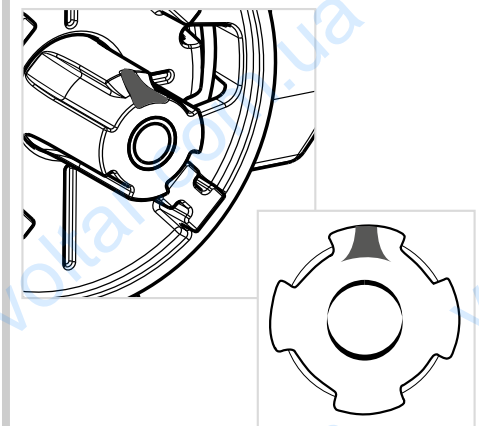

i

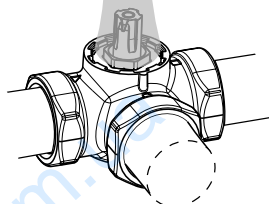
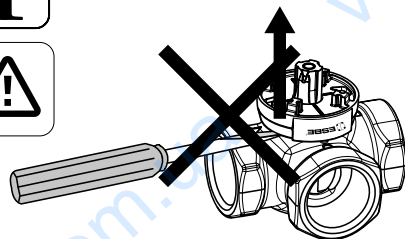

2

a

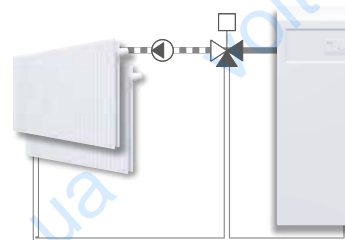
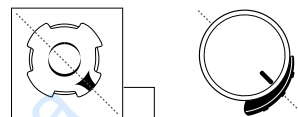

b

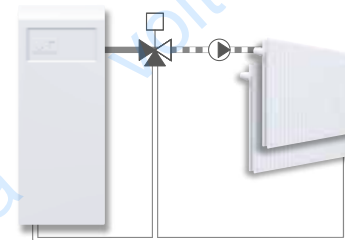
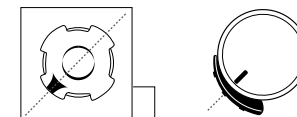

Piping Schematics are General Representations

3

a

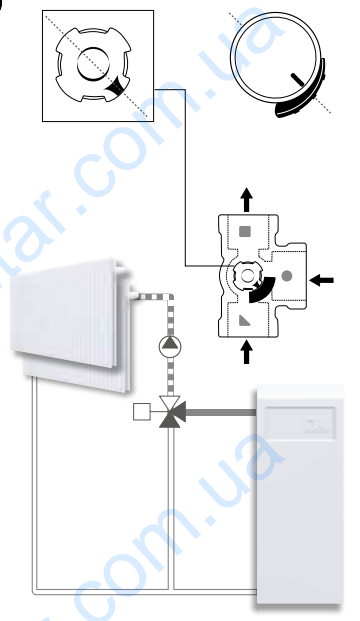

b

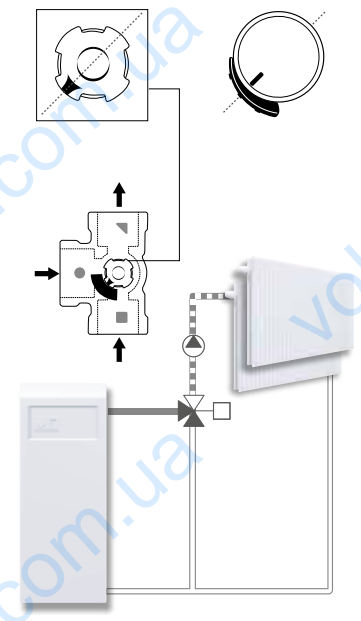

4

a

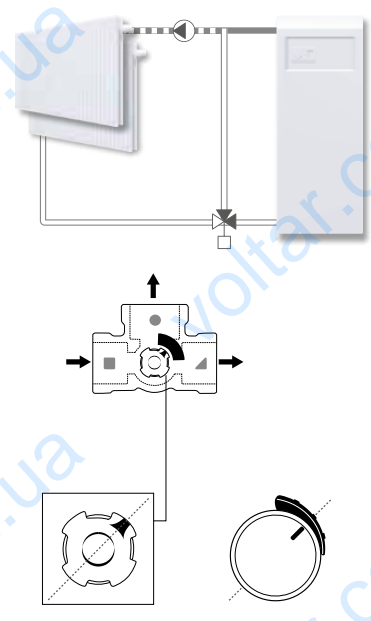

b

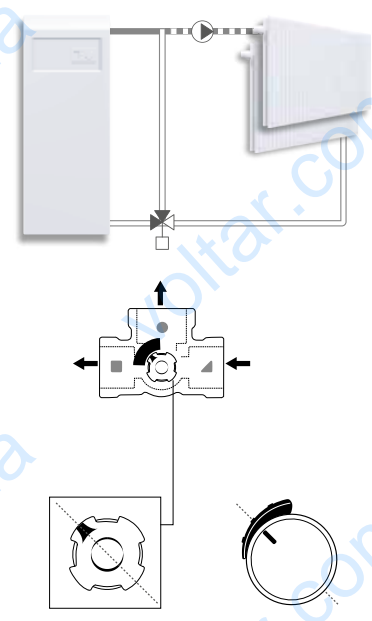

i